



12V

200Ah

SLA

AGM

## 12SLR200DC

Rechargeable AGM Sealed Lead Acid Battery

### SPECIFICATIONS

<b>Nominal Voltage</b>	12V	
<b>Nominal Capacity</b>		
10 hour rate (20A to 10.80V)		200Ah
5 hour rate (34A to 10.20V)		170Ah
1 hour rate (120A to 9.60V)		120Ah
1C (200A to 9.60V)		126.7Ah
<b>Weight</b>	Approx. 75kg	
<b>Internal Resistance (at 1KHz)</b>	Approx. 2.5mΩ	
<b>Maximum Discharge Current (5 secs)</b>	1600A	
<b>Charge Methods at 25°C</b>		
<b>Cyclic Use</b>		
Charging Voltage	14.4V to 15.0V	
Coefficient -5.0mV/°C/Cell		
Maximum Charging Current	60A	
<b>Standby Use</b>		
Float Charging Voltage	13.5V to 13.8V	
Coefficient -3.0mV/°C/Cell		
<b>Operating Temperature Range</b>		
<b>Charge</b>	-15°C to 40°C	
<b>Discharge</b>	-15°C to 50°C	
<b>Storage</b>	-15°C to 40°C	
<b>Charge Retention (Shelf Life) at 20°C</b>		
1 month	98%	
3 months	94%	
6 months	85%	

<b>Case Material</b>	ABS UL94 HB
<b>Termination</b>	F18 (M8 Bolt)

<b>Description of Torque Value of Hardware for the Terminals</b>	
Recommended Torque Value	M8: 12 N-m (122kgf-cm)
Max. Allowable Torque Value	M8: 15 N-m (153kgf-cm)

<b>Design Life</b>	12 years at 20°C
--------------------	------------------

**Classified as a non-spillable battery. Approved for transportation by:**

- Air (IATA/ICAO provision A67)
- Road
- Sea (per IMDG Special Provision 238)



Barcode



9319632520963



### DIMENSIONS

mm (inch)

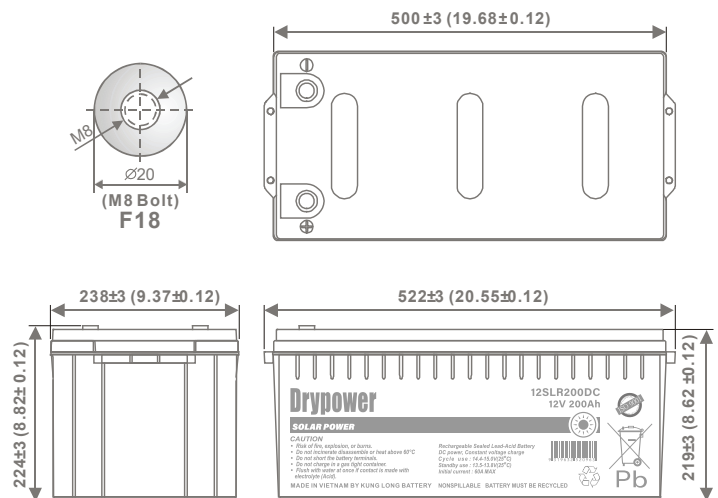

(V) FOR 12V BATTERY **Discharge Time VS. Discharge Current (25°C)**

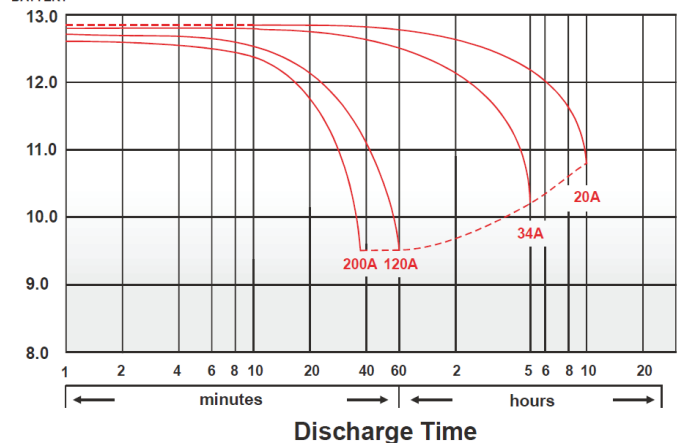

### CHARACTERISTICS CHARTS

#### Relationship Between Temperature and Charging Voltage

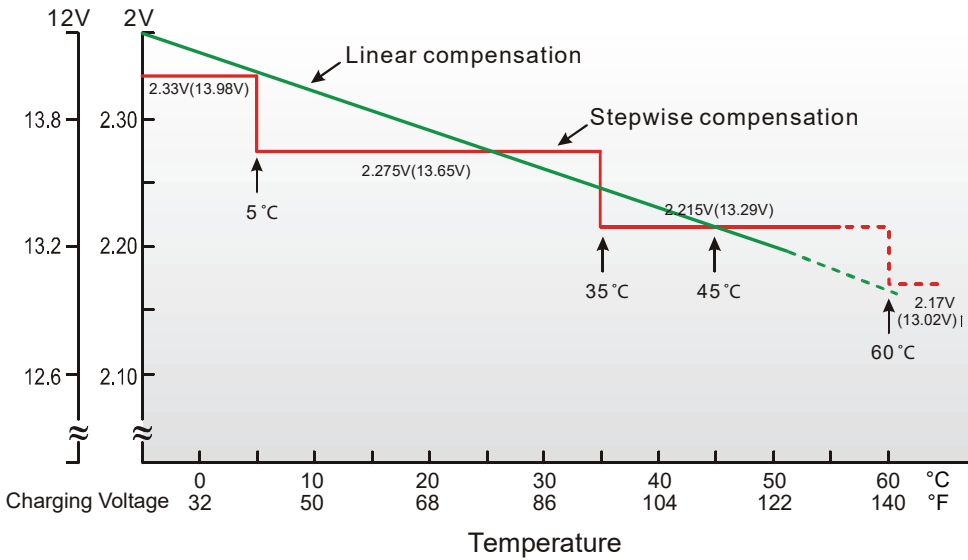

#### FEATURES & BENEFITS

- ◆ Industry leading 99.99% pure lead content for superior service life and dependable performance.
- ◆ Higher percentage of tin content compared with the industry standard to extend battery standby life by minimising sulphation (corrosion) especially at higher temperatures.
- ◆ Robust plate construction to handle varying charge and discharge rates associated with solar systems.
- ◆ Maintenance free technology and non-spillable design.
- ◆ Extremely low self discharge characteristics.
- ◆ Manufactured by Kung Long Battery (KLB) at facilities in Taiwan and Vietnam. KLB is a leading manufacturer and complies with relevant international quality standards including ISO9001, CE ETL9000, UL1989, OHSAS18001 and ISO17025. KLB supports Green Sustainable supply chain practices.



#### Effect of Temperature on Capacity 25°C (77°F)

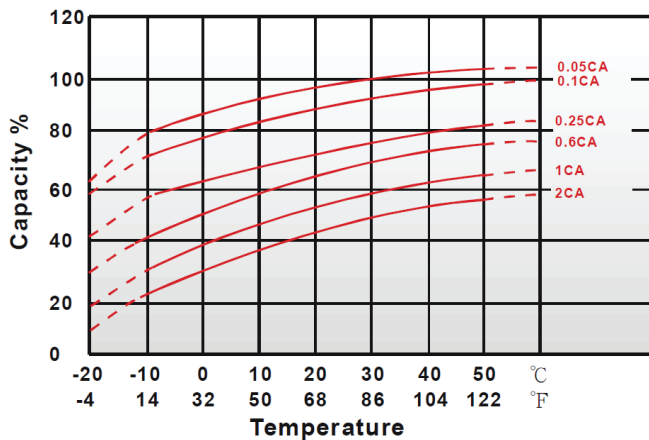

#### Capacity Retention Characteristic

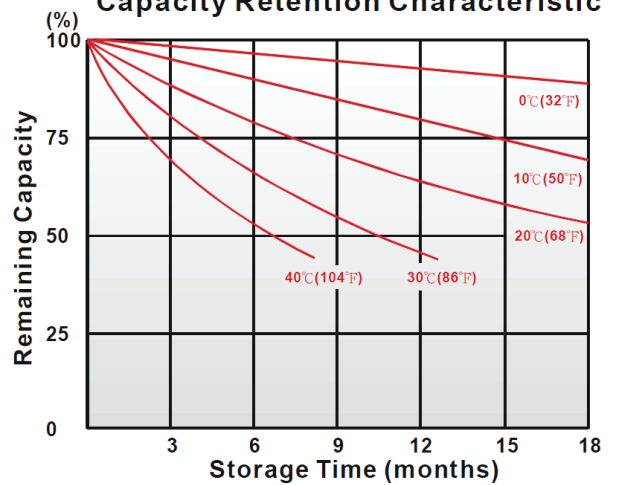

#### Trickle (or float) Service Life

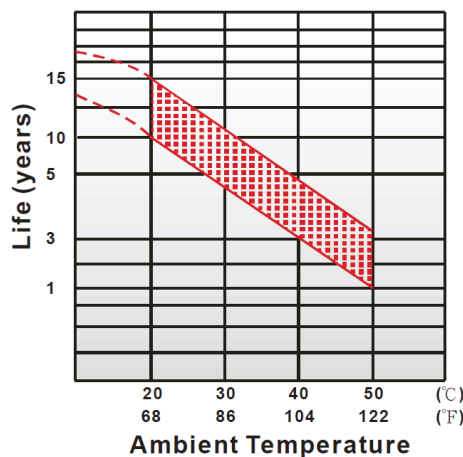

#### Cycle Service Life

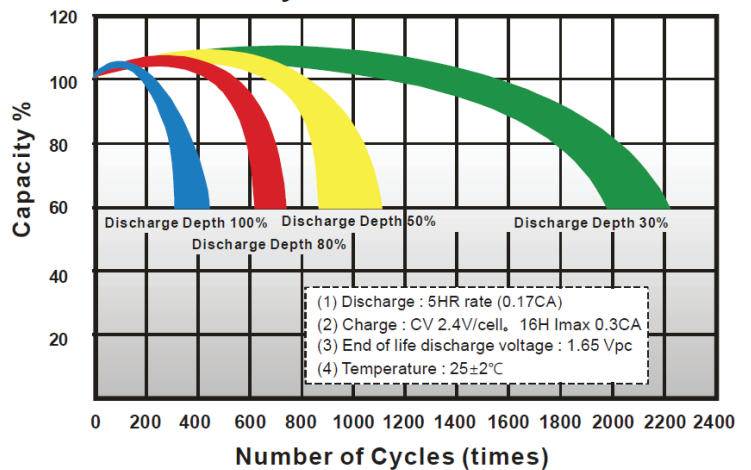

### PERFORMANCE DATA

Discharge Rates in Watts to Various End Voltages at 25°C (77°F)								
End Voltage		1.85V	1.80V	1.75V	1.70V	1.67V	1.65V	1.60V
Time								
10	min	630	700	740	780	790	810	835
15	min	585	622	660	685	700	715	720
30	min	366	389	410	429	437	448	464
60	min	220	232	242	251	254	258	264
90	min	153	164	172	179	182	185	189
120	min	115	125	132	138	140	143	147
180	min	92	98.5	104	108	109	111	112
240	min	80.5	85.2	88.7	91	91.8	92.8	94.2
300	min	70.5	74.3	76.3	77.5	78	78.7	79.5
600	min	37.7	39.5	40.7	41.3	41.7	42	42.5
1200	min	20.3	21.3	21.8	22.2	22.3	22.5	22.7

Discharge Rates in Amperes to Various End Voltages at 25°C (77°F)								
End Voltage		1.85V	1.80V	1.75V	1.70V	1.67V	1.65V	1.60V
Time								
10	min	339	387	422	445	450	462	476
15	min	292	334	361	374	382	391	393
30	min	210	225	238	249	254	260	269
60	min	128	134	143	150	153	157	162
90	min	85.5	92	97.2	102	103	105	108
120	min	66.7	72	75.9	79.1	80.2	81.6	83.5
180	min	48.7	52.3	54.7	57	57.8	58.7	60.4
240	min	37.9	41.1	43.2	44.9	45.5	46.2	47.6
300	min	31.7	34.1	35.9	37.1	37.6	38.2	39.2
600	min	19.8	20.2	20.4	20.6	20.7	20.8	20.9
1200	min	10.2	10.5	10.7	10.8	10.9	11	11.1

All data on the spec. sheet is an average value:

The tolerance range :  $X < 6\text{min}$  (+15%~-15%),  $6\text{min} \leq X < 10\text{min}$  (+12%~-12%),  $10\text{min} \leq X < 60\text{min}$  (+8%~-8%),  $X \geq 60\text{min}$  (+5%~-5%)